











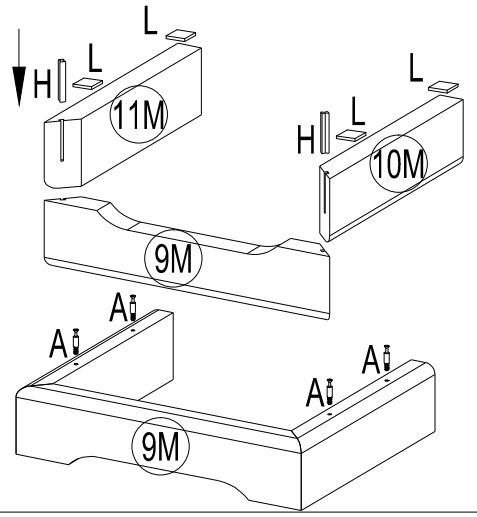
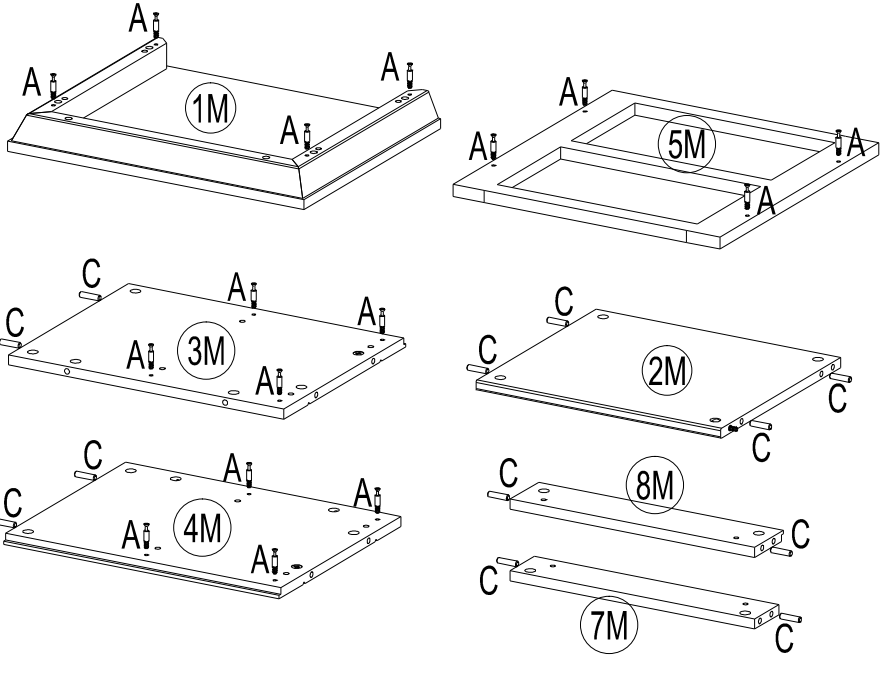
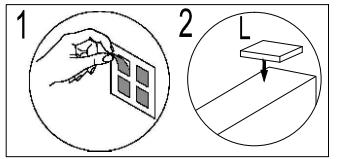
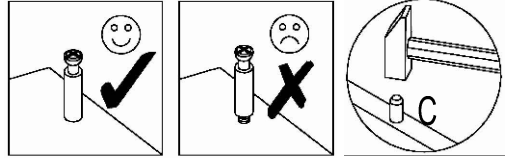

- | | | | | |
|----------|--|---|---|---|
| 1 | A  x20 | C  8x32 x12 | H  60 mm x2 | L  x4 |
|----------|--|---|---|---|

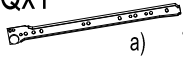

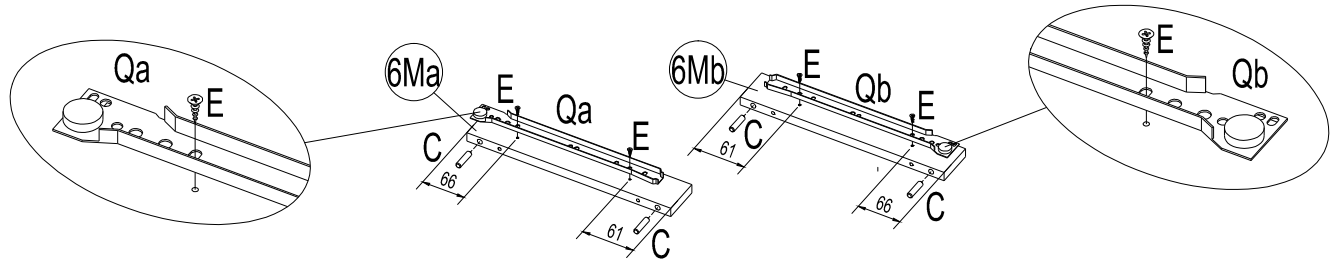





- | | | | |
|----------|---|---|--|
| 2 | C  8x32 x4 | E  3.5x15 x4 | Qx1  a)  b) |
|----------|---|---|--|

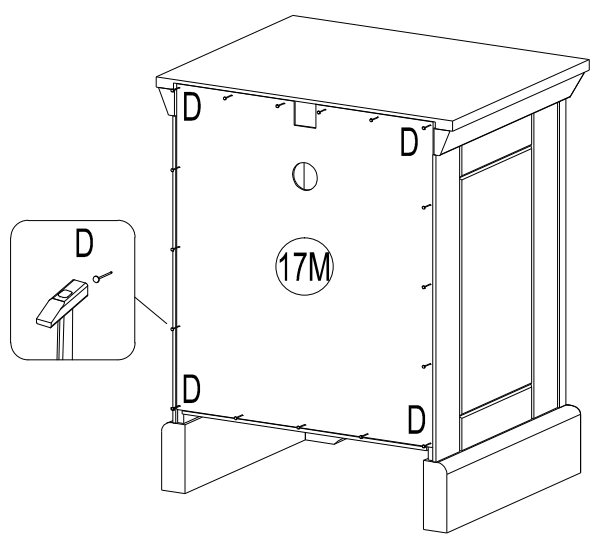
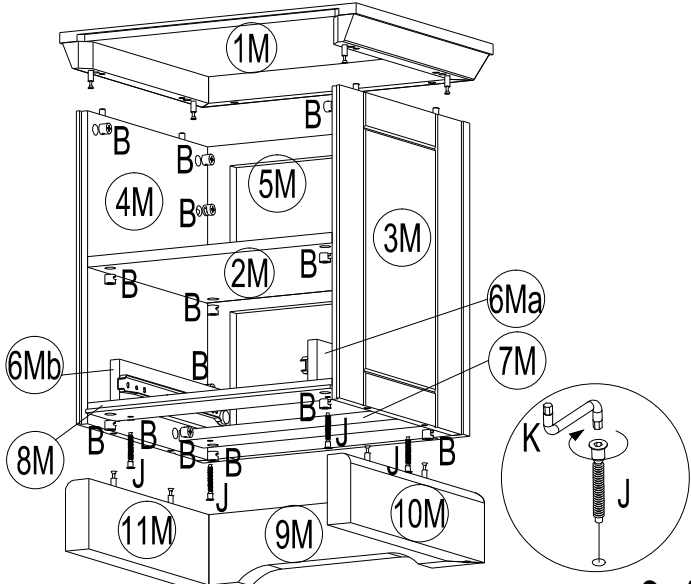

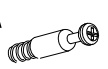

- | | | | |
|----------|--|---|--|
| 3 | B  x20 | J  x4 | K  SW 4 x1 |
|----------|--|---|--|

- | | |
|----------|---|
| 4 | D  1.2x20 x25 |
|----------|---|

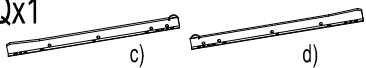

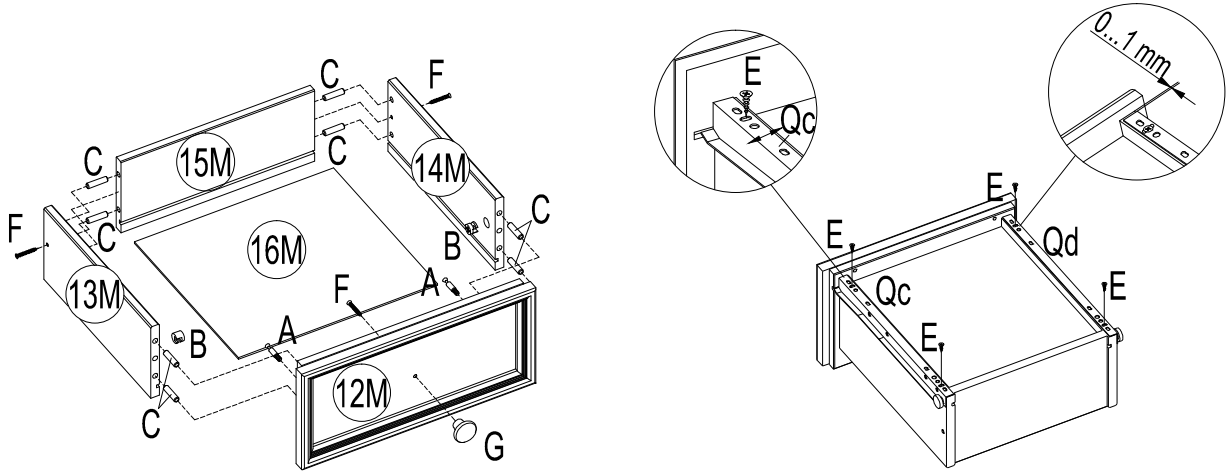
5	A	 x2	B	 x2	C	 8x32 x8	E	 3.5x15 x4	F	 4x35 x3	G	 x1
	Qx1 											

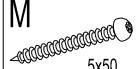
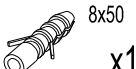
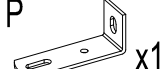

6	E	 3.5x15 x3	M	 5x50 x1	N	 8x50 x1	P	 x1

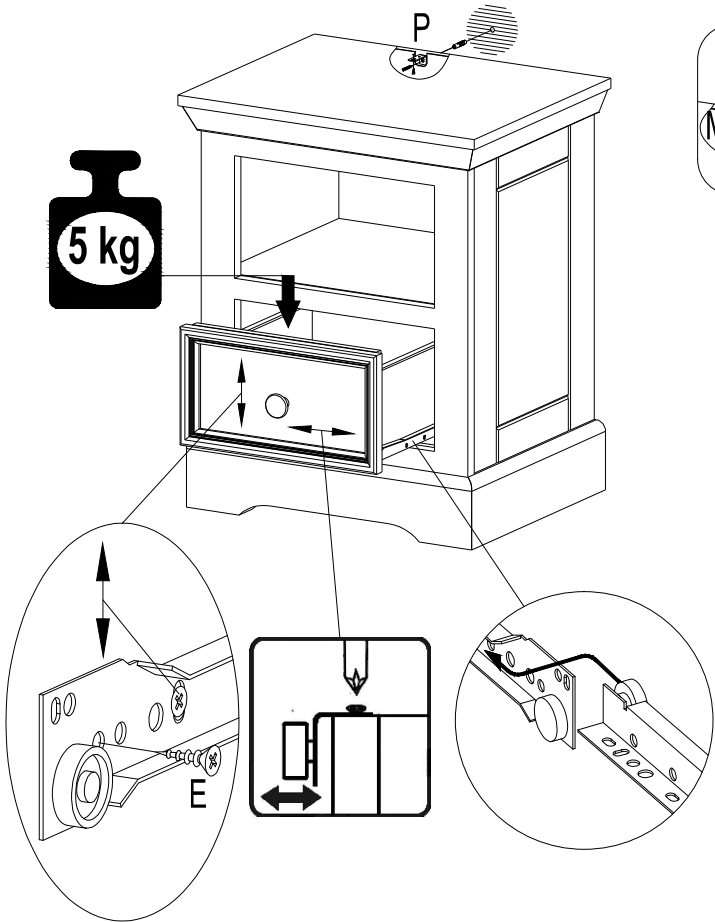

"Prowadnicę szuflady można regulować i ponownie ustawiać w zależności od potrzeb, poluzowując i dokręcając śrubę w otworze."